

KOMATSU

BE30 Series

FB20EX-11 FB20EXG-11

FB25EX-11 FB25EXG-11



**2.0 & 2.5ton
Electric
Pneumatic Tyre
Forklift Trucks**



KOMATSU FORKLIFT



AC TRACTION

The Komatsu BE30 Series features hardworking performance approaching IC engine-powered lift trucks – thanks to new AC technology – with superior traction performance.

It also offers a comprehensive range of performance settings which can be set to tailor the BE30's capabilities to cargo handling, site and job requirements.

And with its easy maneuverability, the ideal electric lift truck is now ready to boost work efficiency wherever and whenever needed.

Why not let the BE30 Series show you the meaning of *real* productivity.

Powerful AC drive motor

Thanks to this powerful AC drive motor, the BE30 Series features superior acceleration, gradeability and travel speed. Which makes it one of your most valuable allies in getting the job done easier, faster and more efficiently.

Acceleration
2.7 sec (0~5m)

FB25EX-11 (unloaded)

Gradeability
20%

FB25EX-11 (loaded)

Maximum travel speed
16.0 km/h

FB25EX-11 (unloaded)



POWER

EXG Series

The BE30 Series also includes a lineup of EXG models that can accommodate up to 1080Ah/5H batteries, enabling them to work an entire day's shift without changing batteries.



FB25EXG

This photographs may contain optional equipment.

Unsurpassed handling and maneuverability

Intelligent Performance Control System

The BE30's performance characteristics can be set individually to custom-tailor its unique capabilities to any cargo handling, site and job requirements. That means maximum work efficiency and productivity any time, anywhere.

Performance setting categories

- Travel power
- Plugging settings
- Brake settings
- Soft start settings
- Accelerator settings
- Accelerator release brake settings
- Downslope settings
- Travel speed limit
- Speed alarm
- Odometer



Intelligent Multi-functional Meter Panel

Set-up examples

- At loading/unloading terminals at distribution centers

Operations involving repeated forward-backward direction changes

Setting travel settings high. Moves with top agility in V-turns and other tight operations between trucks and incoming cargo yard to make light work of maximum cargo in minimum time.

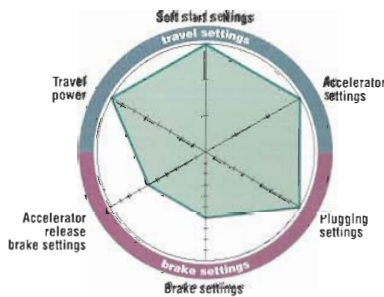

- At sites where cargo requires careful handling

Operations with loads that collapse easily

Set all travel and brake settings low. This will minimize vertical vibrations, so drivers can go about their work with fewer concerns about load collapse and spillage.

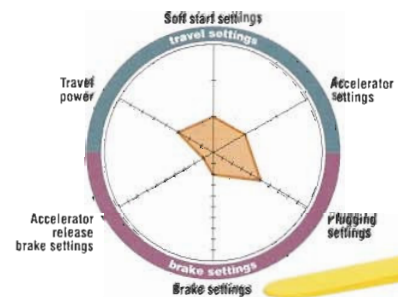

Pitching control

The BE30 Series features a new driving control system to quickly curb pitching as soon as it begins when traveling on unpaved roads or uneven pavement.

New operator's suspension seat

The BE30 Series features newly designed seat cushions with new springs and other parts to help absorb shocks more efficiently and reduce fatigue on long work operations.



Joystick lever (optional)

The BE30 Series lets operators control lift, tilt and attachment with a single joystick, so they can perform side shifter, fork positioner and other operations without changing the grip lever.

* There are two types of joysticks: 3-function and 4-function

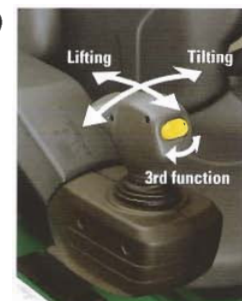

3-function.

Improved ruggedness and durability



Low maintenance costs

The AC motor is another money saver, since it never needs motor brush or contactor replacements. That means lower maintenance costs for top economy.

Superior water resistance

The BE30 Series features not only a layout designed to prevent water from reaching critical parts, but drip-proof components throughout with all electrical components housed in a casing for maximum protection.



Advanced safety features

• Key Off Lock system

The fork and mast will not move with the key in the "OFF" position, even if the lift/tilt lever is activated.

• Travel Neutral safety

BE30 Series lift truck enable to start operating the truck only when the directional lever is in "NEUTRAL" even with the key is in "ON" position, to provide safety starts.

• Notch-release parking brake

The BE30 Series comes with a notch release parking brake lever which cannot be released until the top knob is pushed. A warning buzzer will sound if the vehicle is set in motion before disengaging the parking brake.



• Emergency power off button

There's also an emergency power off button to enable operators to shut down all power with just one touch.



Specifications

		Manufacturer's Designation			FB20EX-11	FB25EX-11	FB20EXG-11	FB25EXG-11	
Characteristics	1.2	Model							
	1.3	Power Type	Electric, Diesel, Gasoline, LPG, cable		Electric	Electric	Electric	Electric	
	1.4	Operation Type	Pedestrian, Driver standing, Sitting, Order picking		Sitting	Sitting	Sitting	Sitting	
	1.5	Rated Capacity	Q	Rated Capacity	kg	2000	2500	2000	2500
	1.6	Load Center	c	Rated Load Center	mm	500	500	500	500
	1.6.1	Alternative Capacity	Q2	Capacity@600mm Load Center	kg	1800	2200	1800	2200
	1.8	Load Distance	x	Front Axle Center to Fork Face	mm	425	430	425	430
	1.9	Wheelbase	y		mm	1400	1400	1550	1550
	Weight	2.1	Service Weight	Including Min. Capacity Battery, See line 6.5		kg	3530	3960	4110
2.2		Axle Loading	Loaded	Front	kg	4860	5735	4985	5795
2.2.1				Rear	kg	670	725	1125	965
2.3			Unloaded	Front	kg	1540	1520	1790	1800
2.3.1				Rear	kg	1990	2440	2320	2460
Tyre	3.1	Tyre Type	Cushion, Elastic Cushion, Pneumatic, Polyurethane		Pneumatic	Pneumatic	Pneumatic	Pneumatic	
	3.2	Tyre Size	Front		23x9-10-16PR(I)	23x9-10-16PR(I)	23x9-10-16PR(I)	23x9-10-16PR(I)	
	3.3		Rear		18x7-8-16PR(I)	18x7-8-16PR(I)	18x7-8-16PR(I)	18x7-8-16PR(I)	
	3.5	Number of Wheel	Front/Rear(x=drive)		2x/2	2x/2	2x/2	2x/2	
	3.6	Tread, Front	b10		mm	940	940	940	940
	3.7	Tread, Rear	b11		mm	950	950	950	950
	Basic Measurement	4.1	Tilting Angle	α / β	Forward/Backward	degree	6/12	6/12	6/12
4.2		Mast Height, Lowered	h1	2-stage Std. Mast	mm	1995	1995	1995	1995
4.3		Std. Free Lift	h2	2-stage Std. Mast from Ground	mm	150	155	150	155
4.4		Std. Lift Height	h3	2-stage Std. Mast from Ground	mm	3000	3000	3000	3000
4.5		Mast Height, extended	h4	2-stage Std. Mast	mm	4050	4050	4050	4050
4.7		Height, Overhead Guard	h6		mm	2100	2100	2225	2225
4.19		Length, with Std. Forks	$\ell 1$		mm	3175	3365	3325	3480
4.20		Length, to Fork Face	$\ell 2$		mm	2255	2295	2405	2410
4.21		Width, at Tyre	b1	Single	mm	1165	1165	1165	1165
4.22		Forks	s/e/l	Thickness/Width/Length	mm	36 x 122 x 920	40 x 122 x 1070	36 x 122 x 920	40 x 122 x 1070
4.23		Fork Carriage Class	ISO 2328, Type A/B/no			ClassII, Type A	ClassII, Type A	ClassII, Type A	ClassII, Type A
4.24		Width, Fork Carriage	b3		mm	1020	1020	1020	1020
4.31		Ground Clearance	m1	Under Mast	mm	110	110	110	110
4.32			m2	at Center of Wheelbase	mm	115	115	115	115
4.33		Right Angle Stacking Aisle	Ast	with L1000xW1200 pallet	mm	3425	3515	3515	3630
4.34	Ast		with L1200xW800 pallet	mm	3625	3645	3715	3760	
4.35	Turning Radius	Wa		mm	2000	2015	2090	2130	
Performance	5.1	Travel speed(FWD)	Loaded/Unloaded		km/h	14.5/16.5	14.0/16.0	14.5/16.5	14.0/16.0
	5.2	Lifting Speed	Loaded/Unloaded		mm/s	290/530	260/530	290/530	260/530
	5.3	Lowering Speed	Loaded/Unloaded		mm/s	450/500	450/500	450/500	450/500
	5.6	Max. Drawbar Pull	Loaded, 3min. rating		N	12700	12700	12700	12700
	5.8	Max. Gradeability	Loaded, 3min. rating/1.5km/h		%	19	16	19	16
	5.10	Service Brake	Operation/Control			Foot/Hydraulic	Foot/Hydraulic	Foot/Hydraulic	Foot/Hydraulic
	5.10.1	Parking Brake	Operation/Control			Hand/Mechanical	Hand/Mechanical	Hand/Mechanical	Hand/Mechanical
	5.10.2	Steering	Type			Power Steering	Power Steering	Power Steering	Power Steering
Drive	6.1	Drive Motor	60 min. rating		kW	10.3	10.3	10.3	10.3
	6.2	Pump Motor	5 min. rating		kW	10.0	10.0	10.0	10.0
	6.2.1	PS Motor	60 min. rating		kW	0.6	0.6	0.6	0.6
	6.4	Battery Voltage			V	48	48	48	48
	6.4.1	Battery Capacity, Min.			Ah/5hr	450	565	935	935
	6.4.2	Battery Capacity, Max.			Ah/5hr	700	700	1080	1080
	6.5	Battery Weight	Min.Capacity Battery, See line 6.4.1		kg	820	925	1375	1375
Others	8.1	Drive Motor Control				Transistor	Transistor	Transistor	Transistor
	8.2	Relief Pressure for Attachment			bar	177	177	177	177
	8.2.1	Reservoir Capacity			Ltr	25	26	25	26

Performance may vary due to operating conditions. The performance shown represents nominal values under typical operating conditions. Specifications are subject to improvements and changes without notice.

Dimension

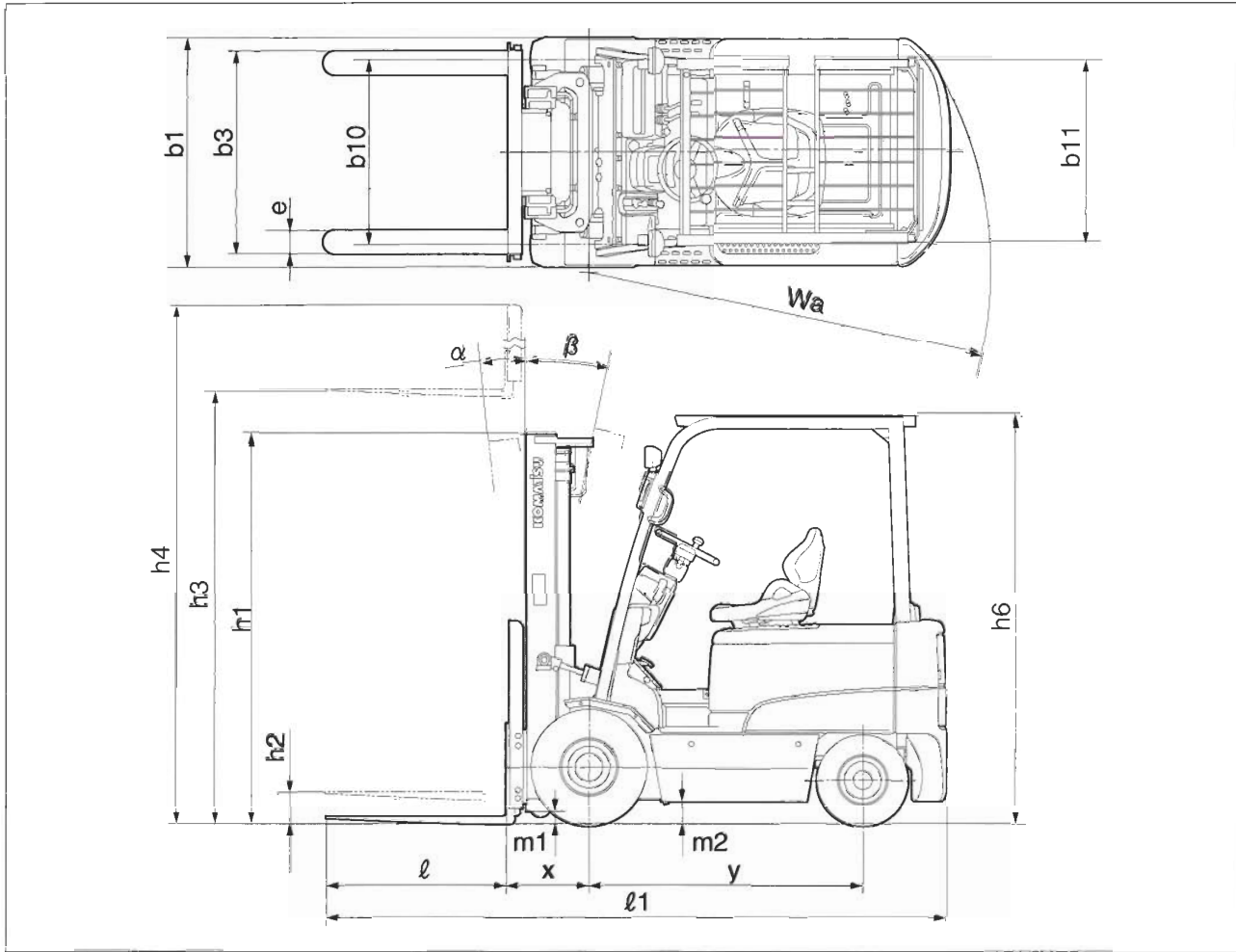

Mast selection & Capacity chart

FB20EX(EXG)

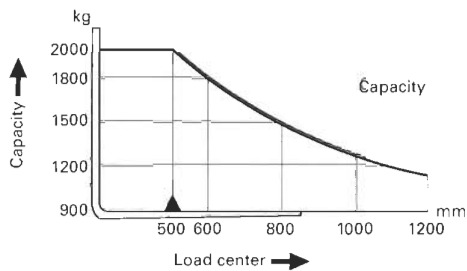

Capacities shown are for trucks equipped with 2-stage view mast up through 4,000mm maximum fork height, 1020mm carriage, 920mm forks. Contact your distributor or dealer for capacity information with other equipment.

FB25EX(EXG)

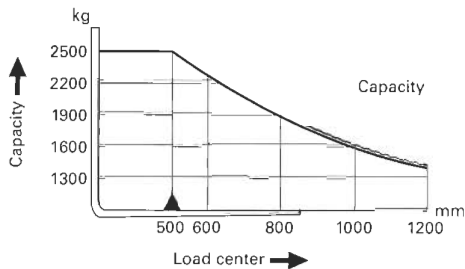

Capacities shown are for trucks equipped with 2-stage view mast up through 4,000mm maximum fork height, 1020mm carriage, 1070mm forks. Contact your distributor or dealer for capacity information with other equipment.

Performance specifications are affected by the condition of the vehicle, and how it is equipped as well as the nature and condition of the operating area. If these specifications are critical, please discuss the proposed application with your distributor or dealer.

FB20/25EX(G)-11

Maximum fork height (mm)	Overall height (mm)		Load capacity* (kg)		Free lift (mm)		Back tilt restriction β
	Lowered h1	Extended h4	FB20EX(G)	FB25EX(G)	FB20EX(G)	FB25EX(G)	
2-stage view mast**							
3000	1995	4050	2000	2500	150	155	12°
3300	2145	4350					
3500	2245	4550					
3700	2345	4750					
4000	2545	5050					
4300	2695	5350	1900	2300	150	155	6°
4500	2795	5550					
4700	2945	5750					
5000	3095	6050	1600	1800			
2-stage full free view mast***							
3000	1995	4060	2000	2500	990	995	10°
3300	2145	4360			1140	1145	
3500	2245	4560			1240	1245	
3700	2345	4760			1340	1345	
4000	2545	5060			1540	1545	
3-stage full free view mast***							
4000	1895	5080	1900	2400	890	895	6°
4300	1995	5380	1850	2300	990	995	
4500	2070	5580	1800	2050	1065	1070	
4700	2145	5780	1800	2050	1140	1145	
5000	2245	6080	1550	1650	1240	1245	
5500	2445	6580	1150	1250	1440	1445	
6000	2645	7080	850	950	1640	1645	

* Load capacity at 500mm load center.

** 1000mm height load backrest.

*** Free lift and overall height(extended) shown are for truck with load backrest.

Large capacity battery compatibility

The BE30 Series lets users choose the battery right for operation time and job content from a wide range of alternatives.

Operation time guide

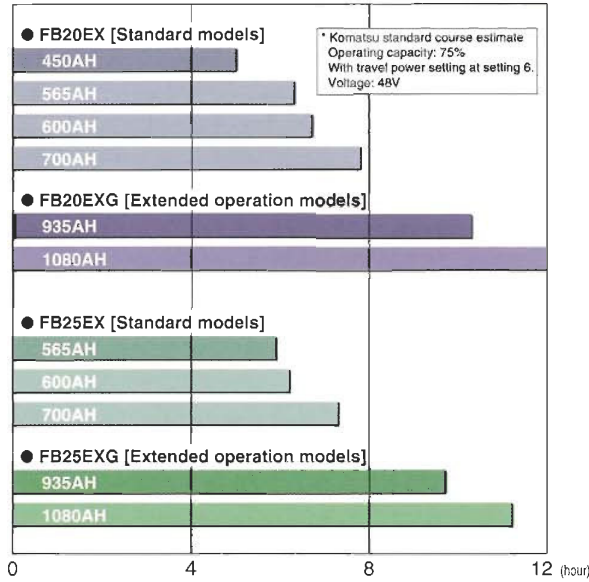

Battery selection

Voltage (V)	Capacity (Ah/5h)	Battery case size Length/Width/Height (mm)	FB20EX	FB25EX	FB20EXG	FB25EXG
			48	450	845 x 980 x 465	○
	565	845 x 980 x 465	○	○		
	600		○	○		
	700		○	○		
	935	990 x 1031 x 591			○	○
	1080				○	○

Battery charger specifications

Voltage (V)	Applicable battery capacity (Ah/5h)	Input voltage AC(V)	Input current (A)		Max. input power (KVA)	
			(50Hz)	(60Hz)	(50Hz)	(60Hz)
48	330-450	340-460	9.5	8.4	6.6	5.8
	440-560	340-460	15	12	10.4	8.3
	560-730	320-460	15	14	10.4	9.7
	730-1080	340-461	20	17	13.9	11.8

Standard Equipment

- Multi function digital meter panel — Hour meter, Speedometer, Battery discharge indicator, Speed limit indicator, Parking brake indicator, Travel power indicator, Calendar (Year/Month/Day/Date/Time)
- Travel neutral safety system •Lift/ Tilt key off lock system •Regeneration braking system •Emergency power off button
- Anti-rollback •Soft landing devices (Fv mast only) •Notch-release parking brake •Operator's suspension seat with weight adjust
- Stow pocket & memo binder •Floor mat •Overhead guard •Load backrest •Drawbar pin •Electric power steering
- Telescopic-tiltable steering column •Headlights •Turn signal lamps with self-canceling •Rear combination lamps

Options

- Battery and Charger •Back-up buzzer •Joystick •Rear view mirror •Rear working light •Elastic cushion tyre

Attachments

- Side shifter •Fork positioner •Bale clamp •Paper roll clamp •Rotating fork •Load stabilizer •2-stage free view mast
- 2-stage full free view mast •3-stage full free view mast

The illustrations do not necessarily show the standard version and features of the equipment. Features and specifications may vary by country and region. Products and specifications are subject to change without prior notice. Please contact your Komatsu dealer for detail information.

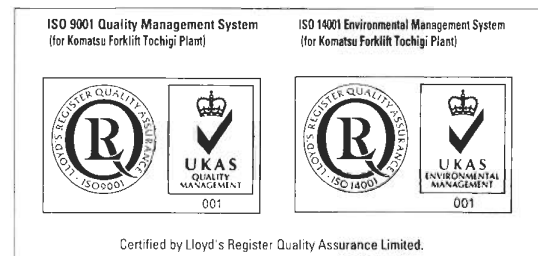

Komatsu Forklift Co., Ltd.

Head office 2-3-4, Akasaka, Minato-ku, Tokyo 107-8474, Japan

<http://www.lift.co.jp>

Fax 81-3-3224-7551 (Tokyo, Japan)