

ENGINE POWERED FORKLIFT

7FG/7FD 3.5 to 5.0 ton

7 SERIES



 **TOYOTA**

You will appreciate the difference immediately.



Features and equipment may vary depending on market.

The difference between the ability of an experienced operator and that of a rookie is clear at a glance. It's just the same with forklifts. Introducing the Toyota 7FG/7FD35 to 50, the forklift proves once and for all that productivity and safety are compatible goals. Toyota's original SAS (System of Active Stability) electronic control technology combines high performance with ease of operation with an excellent standard of safety. Everything from the engine to the handling has been improved, providing smoother operation and more environmentally friendly use than ever. For its ease of operation, safety, and environmental friendliness, 7FG/7FD35 to 50 is without equal. It sets a new standard for the professional use forklift.

**Smooth, safe operation.
The new professional standard.**



Features and equipment may vary depending on market.

Safety functions that professionals look for

How do you help a skilled professional forklift operator do a better job? How do you enhance safety without sacrificing efficiency? Toyota has found the answer by blending advanced technology with its many years of forklift manufacturing experience. The key is the development of Toyota's proprietary System of Active Stability (SAS) electronic control technology. The computer-assisted stability enhancement of SAS will be appreciated by even the most experienced operators.



Smooth turning for excellent stability.

Active Control Rear Stabilizer **SAS**

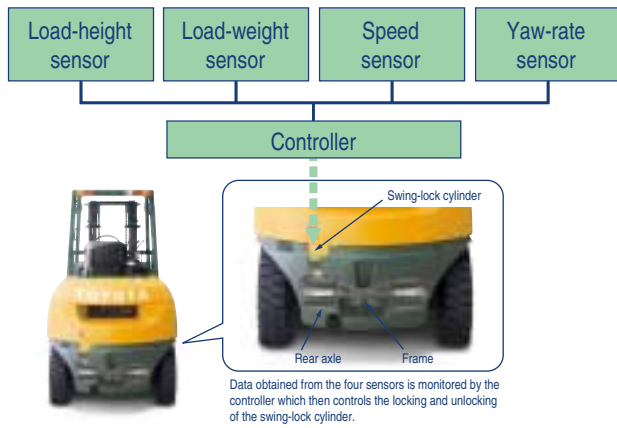

To counteract the inherent instability of forklifts when turning, the Active Control Rear Stabilizer employs four separate sensors to monitor load height and weight, and vehicle speed and yaw rate. Lateral stability is then controlled by the on-board computer that locks and unlocks the swing-lock cylinder, suppressing rear-axle swing, to ensure constant balanced floor contact. This results in superior turning ability and significantly reduces the risk of overturn.

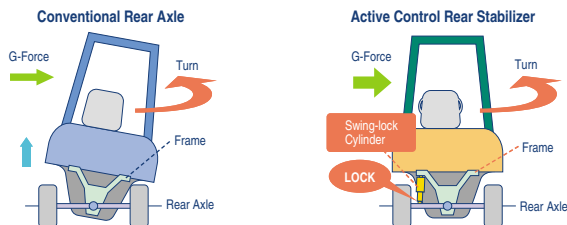



Features and equipment may vary depending on market.

High-level of longitudinal stability keeps loads on the forklift, thereby preventing damage.

Active Mast Function Controller SAS

This function enhances both the lateral and longitudinal stability of the forklift when handling loads at high lift heights.

Active Mast Front Tilt Angle Control

A computer controls the amount of forward mast tilt based on the lift height and the weight of the load.

This function can help reduce the risk of the load spilling or the forklift overturning as a result of an operational error.

Active Mast Rear Tilt Speed Control

To reduce the possibility of the load falling, the on-board computer controls the mast's rear tilt speed according to the lift height—slow when the lift is high and fast when it's low—for easier and more efficient handling of loads.

Key-Lift Interlock

When the engine is turned off the Key-Lift Interlock uses hydraulic pressure to lock the forks in position.*

Leak-less Valve System

The Leak-less Valve System reduces the likelihood of loss of hydraulic pressure that might cause the forks to drop and the mast to tilt forward.*

*ALWAYS fully lower fork and turn off engine when leaving forklift unattended.

Operator Presence Sensing System OPS

The Operator Presence Sensing system (OPS) is standard equipment. This system uses a switch sensor built into the operator's seat to detect the presence of the operator. If the operator is not in the normal operating position, travel power is interrupted and load handling operations are stopped.

Note: OPS does not operate the brakes. Always set the parking brake before leaving the forklift.

Travel OPS is not available on manual transmission models.



Functionality that professionals value

Our aim is to create forklifts that operate like natural extensions of the operator's hands and feet. To achieve this we introduced technologies like the Automatic Fork Leveling Control, which returns the forks to the horizontal position at the push of a button, and the Active Steering Synchronizer, which helps to correct the misalignment between the steering wheel angle and the steered angle of the rear tires, enhancing operation in tight areas.

Secure horizontal fork positioning makes the job easier.

Automatic Fork Leveling Control **SAS**



Pressing the switch on the top of the tilt lever will return a rear-tilted mast to the upright position and automatically level the forks. When handling pallets, this function helps speed the removal and insertion of the forks, boosting efficiency.

Excellent maneuverability boosts productivity ideal for confined workplaces.

Active Steering Synchronizer **SAS**



Combined with Fully Hydraulic Power Steering (FHPS), this system eliminates knob play and allows fixed position circling, maximizing on-demand operator motive force for outstanding maneuverability and swift response.

Comparison chart

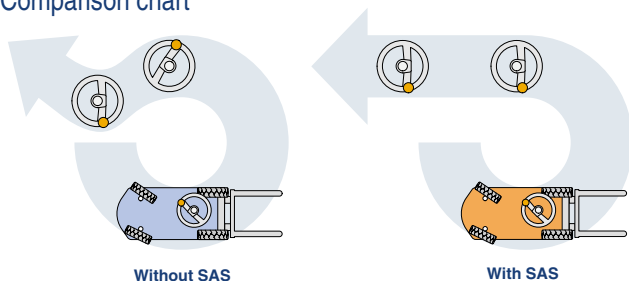



Multifunction Display/ Deluxe Multifunction Display **OPT**

The Multifunction Display provides useful information for efficient operation. The photographs below show some of the various display screens. There are also password-protected functions for use by supervisors or managers.



• Digital speedometer



• Torque-converter oil temperature warning

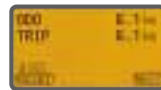

• Odometer and Trip meter



• Scheduled-maintenance hour warning indicator

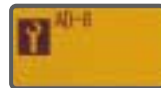

• Diagnostic code display

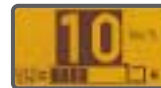

• Over-speed alarm (DX)



• Over-speed alarm setting (DX)



• Load meter (DX)



Integrated Light & Turn Signal Switch

The Integrated Light & Turn Signal Switch, similar to that found in passenger cars, allows for fingertip control of the headlights and turn signals.



Clear-View Mast

An unobstructed view is a fundamental requirement for safe and smooth forklift operation. The Clear-View Mast design gives the operator unimpeded visibility and a clear view of the fork tips from a natural operating position that reduces fatigue and improves productivity.

Double-Action Parking Brake

The Double-Action Parking Brake is easy and convenient to use.



Tough on the outside; gentle on the inside

It was long thought that forklifts are inherently uncomfortable. We've dispelled that myth. Relieving operator stress is the key to enhancing productivity. So while improving the fundamental performance of the forklift, we also enhanced its spaciousness and comfort. And to improve durability, we re-evaluated everything from the design process to the selection of part materials. Everything we did was for "making the operator's job easier at any work place," which we did by making forklifts that are both tough and gentle.

For increased operator comfort and working efficiency.

Expanded foot space

The use of Full Hydraulic Power Steering (FHPS), which requires less installation space, and covered tilt cylinders help provide a wider foot space. More foot space means the operator has more freedom of movement and that helps reduce fatigue. The comfort of the operator compartment is further enhanced by a lower panel that separates the pedal link from the operator's area. The result is reduced fatigue, comfortable operation and increased efficiency.



Steel Cabin **OPT**

The sealed cabin shuts out dust as well as foul weather to provide comfortable operation. Spacious glass areas ensure excellent forward visibility. Large doors open wide for easy entry and exit. They are easily removed for operation during hot weather. A heater with defroster is also optionally available for further comfort.





Features and equipment may vary depending on market.

ORS Seat

This side-wing and seat-belt equipped Operator Restraint System (ORS) seat wraps the operator in both safety and comfort. It offers 150mm adjustment longitudinally.

The Suspension Seat with Damper is optionally available. It offers a full 50 mm suspension stroke that provides a smoother ride.



*ORS: Operator Restraint System

Mini Lever **OPT**

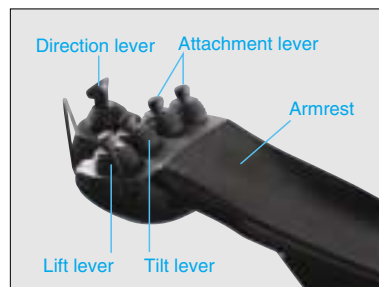

These small, easy-to-operate levers provide total load handling operation and travel direction selection. A fatigue-reducing armrest is provided.

Joy Stick **OPT**

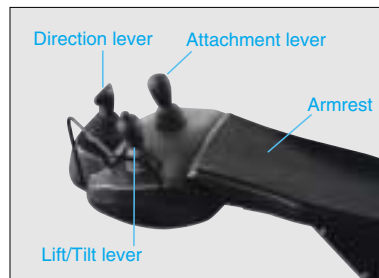

Lift and tilt operations can be operated with a single lever. Lift and tilt operations can be performed simultaneously.

Rain Gutter



A rain gutter has been added to the overhead guard on the front side of the roof. Its lateral drainage prevents rainwater that has accumulated on the overhead guard from dripping onto the operator.

Water-Resistant Connectors

Connectors for most electrical components are highly water-resistant, increasing the reliability of the electrical system.

Environmental friendliness that professionals demand

Toyota, as a manufacturer of forklifts powered by diesel and gasoline engines, recognizes that cleaner exhaust emissions and lower noise levels are of the utmost priority for providing a clean and quiet workplace. Detailed revision of engine designs, focusing on increasing the efficiency of the intake and exhaust system and transmission and engine mounts have all helped to provide the 7FG/7FD35 to 50 with clean emissions, low noise and vibration levels, and energy-saving performance.

14Z-II Diesel Engine



Toyota 14Z-II is a 5.2-liter in-line 6-cylinder diesel engine. It has been specifically designed for use in industrial vehicles and features a uniquely shaped combustion chamber and a **direct-injection fuel system**.

The 14Z-II provides high output while reducing exhaust gas emissions. The full-floating engine mount design and large muffler help to reduce noise and vibration.

DPF-II **OPT**

The Diesel Particulate Filter DPF-II enhances the 'black-smoke' particulate elimination capability through use of the improved physical and chemical properties of new filter materials that also prolong filter life.

(Nearly 100% Elimination of Diesel particulate matter)



1FZ-E Gasoline Engine



Toyota 1FZ-E engine is a 4.5-liter twin-cam, 24-valve, in-line 6-cylinder gasoline engine that is based on the field-proven 1FZ engine. It now has electronic control for the governor and fuel and ignition systems. The 1FZ-E with the electronic control system provides 15%* better fuel efficiency and approx. 2% more horsepower than the previous 1FZ engine.

* These are approximate figures based on the 50 meter work cycle test results conducted by Toyota. Actual performance may vary.

3-way Catalytic Converter System **OPT**

The 3-way Catalytic Converter System is optionally available for the 1FZ-E engine. It can satisfy the needs of customers who give priority to a cleaner working environment.

Low Operation Noise and Vibration

The drive-trains feature an advanced full-floating design that achieves low levels of noise and vibration.

Low Noise Model **OPT**

Toyota offers the Low Noise Model that is equipped with various of noise-reducing components.



Environmentally Friendly Design

The 7FG/7FD35 to 50 is free of harmful materials, such as asbestos, mercury and cadmium. The amount of lead and hexavalent chromium has also been dramatically reduced in order to minimize the affect on the environment.

Features and equipment may vary depending on market.

MODEL VARIATION



MAIN SPECIFICATIONS

Model		7FG35	7FD35	7FGK40	7FDK40	7FG40	7FD40	7FG45	7FD45	7FGA50	7FDA50
Engine Model		1FZ-E Gasoline	14Z-II Diesel	1FZ-E Gasoline	14Z-II Diesel	1FZ-E Gasoline	14Z-II Diesel	1FZ-E Gasoline	14Z-II Diesel	1FZ-E Gasoline	14Z-II Diesel
Load Capacity	kg	3500 (4000)		4000 (4500)		4000 (4500)		4500 (5000)		5000	
Load Center	mm	600 (500)		600 (500)		600 (500)		600 (500)		600	
Overall Width	A mm	1350		1350		1450		1450		1450	
Turning Radius(outside)	B mm	2610		2660		2710		2760		2810	
Overhead Guard Height	C mm	2140		2140		2235		2235		2235	
Length to Fork Face	D mm	2935		3000		3080		3140		3180	

NOTE: () for 500 mm Load Center.

ENGINE SPECIFICATIONS

Model		TOYOTA 1FZ-E Gasoline	TOYOTA 14Z-II Diesel
Piston Displacement	cc	4476	5204
Rated Horsepower/r.p.m.	kW	63/2350	56/2100
Rated Torque/r.p.m.	N-m	294/1200	269/2100

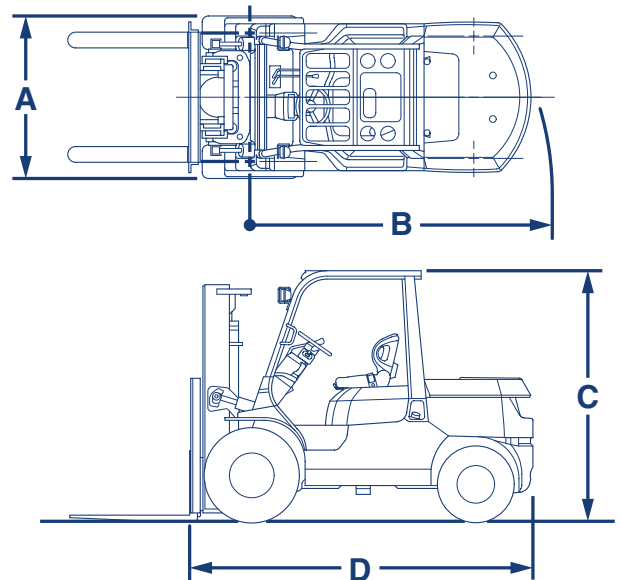

The data in this brochure is determined based on our standard testing condition. The performance may vary depending on the actual specification and condition of the vehicle as well as the condition of the operating area. Availability and specifications depend on region and are subject to change without notice. Due to photography and printing, color of actual vehicle may vary from this brochure. Some photos have been computer-enhanced. Please consult your Toyota representative for details.

All rights reserved by Toyota Industries Corporation.